

Scotsman[®]

USE AND
ORDINARY
MAINTENANCE



GOURMET ICE

AC | EC SERIES

MXG SERIES



Dear Customer,

this manual contains all the information necessary for the use and routine maintenance of the product.

We therefore recommend that you read it carefully before use and keep it carefully for future reference.

If any step is not understood well, the Manufacturer remains available to provide any information.

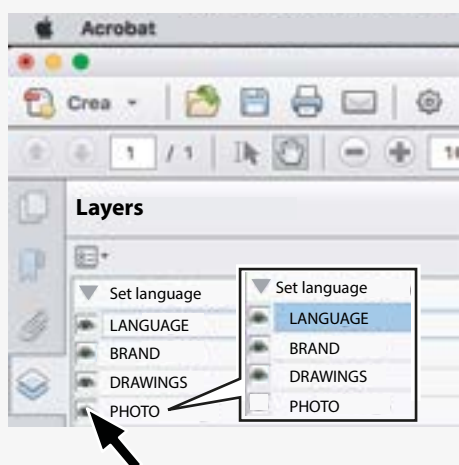

This booklet in digital format is interactive; for example, a simple “click” of the mouse on the writings or on the page numbers gives direct access to the contents indicated.

If you need to print the booklet, it is advisable to deactivate the “Photo” level from the Acrobat menu.

Drawings and texts will be printed but the background photos will be hidden: in this way it will be possible to save a lot of printing ink and, consequently, protect the environment!

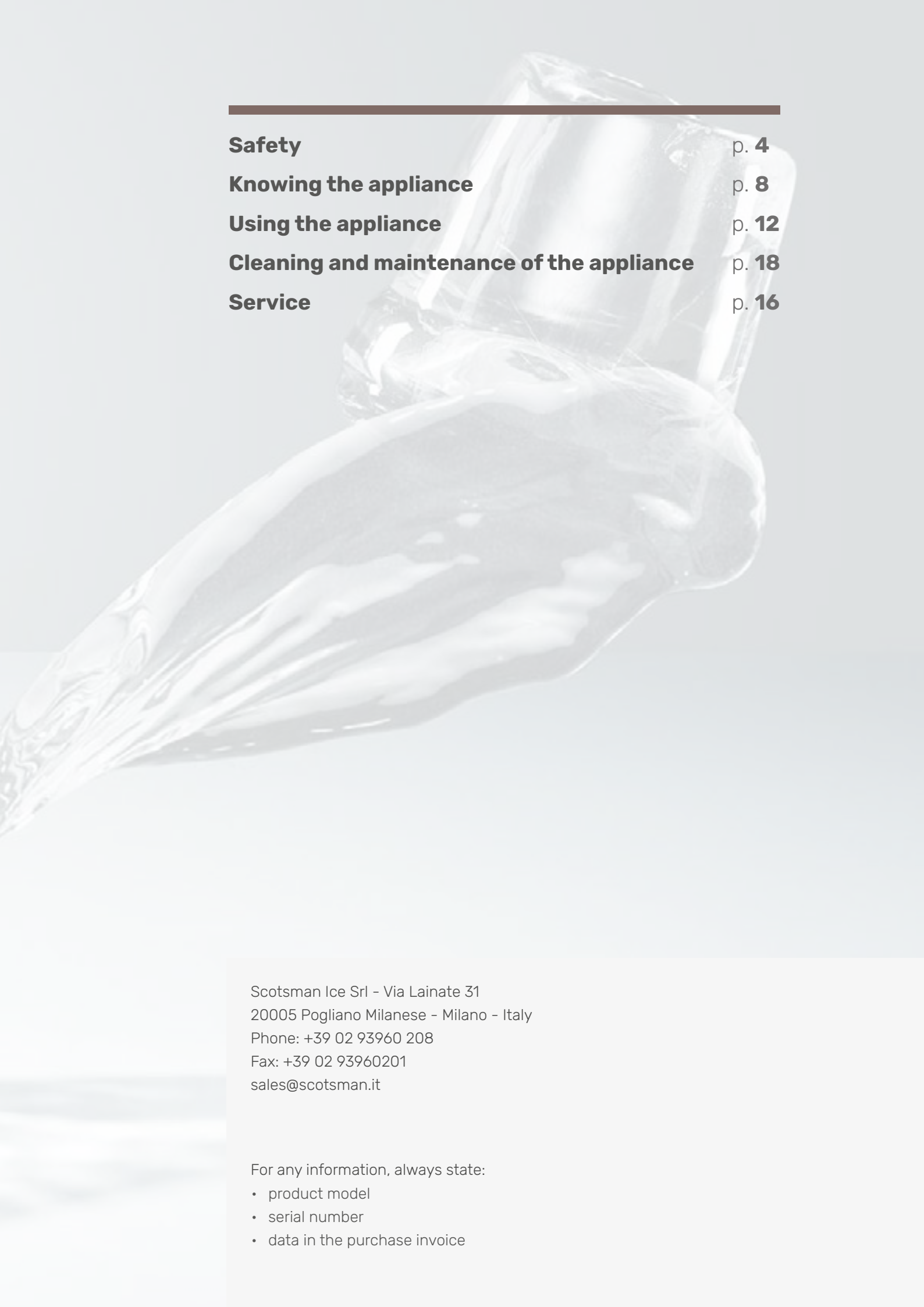

Safety	p. 4
Knowing the appliance	p. 8
Using the appliance	p. 12
Cleaning and maintenance of the appliance	p. 18
Service	p. 16

Scotsman Ice Srl - Via Lainate 31
20005 Pogliano Milanese - Milano - Italy
Phone: +39 02 93960 208
Fax: +39 02 93960201
sales@scotsman.it

For any information, always state:

- product model
- serial number
- data in the purchase invoice

SAFETY

Pictogram explanation



Indicates that caution is required when performing an operation described in a paragraph that bears this symbol. The symbol also indicates that maximum operator awareness is required in order to avoid unwanted or dangerous consequences



Indicates important information to be read and complied with.



Indicates requirements relating to actions that must be avoided.



This symbol placed on the appliance or used in the manual identifies the areas with an electrical hazard.



Indicates grounding



Indicates that it is necessary to read carefully the paragraph marked with this symbol before installing, using and maintaining the product

Safety warnings

WHO IS THIS MANUAL FOR?

The pages identified with this symbol are mainly addressed to the user, who must read them carefully before use and routine maintenance (cleaning) of the appliance. If you have not understood the whole content of the manual, contact your local distributor or Dealer before working on the appliance. Given the continuous progress in the design sector, the Manufacturer reserves the right to make changes to the production and instructions, without this entailing the obligation to update the production and previous instructions. If necessary, further copies or updates of these instructions must be requested from the Manufacturer.

INTENDED USE AND CLASSIFICATION

This appliance is an ice maker and must only be used for making ice (not as a container for bottles, cans, etc.)

-  The appliance is designed to be used in domestic and similar applications such as:
- the kitchen area for staff in shops, offices and other work environments;
 - farms and by customers in hotels, motels and other residential-type environments;
 - bed and breakfasts;
 - catering services and similar applications, not for retail.

OPERATING LIMITS

	Minimum	Maximum
Working temp.	10°C	43°C
Water temperature	5°C	38°C
Water pressure	0.1 MPa 1 Bar	0.5 Mpa 5 Bar
Voltage tolerance with respect to the data indicated on the plate	-10%	+10%
Sound level produced by the operation of the appliance	< 70 dB(A)	

GENERAL WARNINGS

 Partial or total non-compliance with these instructions and following prescriptions, improper installation, use, ordinary or extraordinary maintenance or other than those indicated in the manual or the tampering with or modification of the appliance or some of its parts (unless expressly authorized), use of non-original or non-specific spare parts for the model, unauthorized interventions:

- can cause damage, injury or death;
- void the warranty
- reduce or compromise the quality and safety characteristics of the appliance;
- release the Manufacturer from any liability.

 It is absolutely forbidden to tamper with or remove the safety devices adopted (protective grids, danger stickers, etc.). The Manufacturer declines all responsibility if the above instructions are not complied with.

 Use or routine maintenance (cleaning) other than those mentioned in the Manual may cause damage, injury or fatal accidents.

 This appliance can be used by children aged 8 and over and by people with reduced physical, sensory or mental abilities or with a lack of experience and knowledge only if they have been adequately instructed and supervised in the safe use of the appliance and have learned the possible dangers derived from its use. Children must be supervised to make sure they do not play with the appliance.

 If the power cable is damaged, have it replaced ONLY by QUALIFIED PERSONNEL in order to prevent any risks.

 Before carrying out any routine cleaning or extraordinary maintenance, it is necessary to disconnect the appliance from the power supply, close the water tap and wear suitable personal protective equipment (e.g. gloves, etc.).

 If the appliance does not work or functional or structural alterations are noted, disconnect it from the power and water mains (if provided) and contact a service centre authorised by the Manufacturer without attempting to repair it on your own. The use of original spare parts is mandatory. The Manufacturer accepts no liability for the use of non-original spare parts.

 If the appliance is being repaired, highlight with appropriate signs placed in a visible position that it CANNOT be used.

 Do not place objects that cause poor ventilation on and around the appliance. In particular, make sure that the front and/or side ventilation openings are always free from obstructions.

 Do not store explosive substances in this appliance, such as aerosol cans with flammable propellant.

 Do not use electrical devices inside the application container, unless they are of the type recommended by the Manufacturer.

 Do not place any solid or liquid object on top of the machine and do not use it as an anchor.

 Do not sit on top of the machine.

 Do not work on the machine with wet hands or bare feet.

 For small movements of the appliance, it must always be lifted. NEVER push or drag it.

 The rating plate provides important technical information that is vital in case of a request for maintenance or repair of the appliance: please do not remove, damage or modify it.

 To ensure the best conditions of use and safety of the appliance, once or twice a year (or according to the provisions of the national

regulations in force) contact the Dealer or the local distributor to have the appliance checked so that it undergoes extraordinary maintenance (washing, descaling and sanitizing the water circuit and replacing the XSafe lamp - if any).

The Manufacturer's warranty does not cover oxidation due to installations in marine environments or in the presence of salt.

 The state of the machine stopped, detected by means of a visual inspection of the same, does not guarantee with certainty that the device is turned off. In order to protect his own safety, the operator must check that the machine is not powered, that is, that its plug is disconnected or that the switch of the panel to which it is connected is in the "OFF" position.

 This manual is an integral part of the appliance and must accompany it throughout its useful life. Store the manual carefully, in a dry and accessible place, near the location of the device for any further future consultation by the various operators when they need it.

 The appliance must be easily moved for any extraordinary maintenance: pay attention that any masonry work subsequent to installation (e.g. construction of walls, replacement of doors with narrower ones, renovations, etc.) do not hinder movement.

 Caution! Do not install the machine on containers with an area lower than the base of the machine.

 When cleaning any part or accessory do NOT use:

- abrasive or powder detergents;
- aggressive or corrosive detergents (e.g. hydrochloric or sulphuric acid, caustic soda, etc.). Caution! Never use these substances also when cleaning the floor under the appliance;
- abrasive or sharp tools (e.g. abrasive sponges, scrapers, steel brushes, etc.);
- steamed or pressurised water jets.

INSTALLATION INSTRUCTIONS

- ⚠ Installation must be performed by authorized technicians.
 - ⚠ When installing the machine, replace the existing water supply tubes with the new ones supplied with the appliance
 - ⚠ Place the water drain hose(s) supplied in the relative drain.
 - ⚠ Attention, use only drinking water.
 - ⚠ The water supply tap must be within reach of the operator. The installation of a softener filter for the water connection is recommended. For the installation, contact your local official distributor.
 - ⚠ Before installation and periodically during use, check that the power cable is not torn or damaged.
 - ⚠ If the power cable is damaged, have it replaced **ONLY** by **QUALIFIED PERSONNEL** in order to prevent any risks.
 - ⚠ It is mandatory to connect the appliance to a wall switch installed on the power line.
 - ⚠ Do not place multiple sockets or portable sockets behind the application.
 - ⚠ The main switch and/or the electrical outlet must be close to the appliance and within reach of the operator.
 - ⚠ During the installation, check that:
 - the socket of the power supply line is earthed.
 - the contact opening distance allows complete disconnection in the conditions of category III overvoltage. Disconnection devices must be incorporated into the power supply in compliance with the installation rules.
 - the appliance has a minimum distance of 150 mm from the walls to allow sufficient ventilation;
 - the appliance is perfectly level.
- Installation in accordance with 3500.1 and 3500.2.

REFRIGERANT GAS SAFETY WARNINGS

- ⚠ Propane is a highly flammable gas.
- The appliance contains fluorinated greenhouse gases governed by the Kyoto protocol, in the quantities indicated on the serial plate.

- The GWP (Global Warming Potential) of:
 - HFC R404A is 3750;
 - HFC R452A is 2140;
 - HFC RE134A is 1430;
 - R290 is 3.

The propane used in refrigeration systems is odourless and heavier than air; in case of refrigerant leaks it migrates to the ground.

- The system is hermetically sealed.

SAFETY WARNINGS FOR UV LAMPS

This natural sanitation system based on the UV lamp is integrated inside the machine and guarantees absolute purity and hygiene:

- *treats the air with ozone technology in the food area of the ice maker;*
- *keeps the ice maker and the container clean, reduces mould, viruses and other microorganisms;*
- *it is fully automated and chemical free.*

- ⚠ This machine contains an apparatus that emits UV and generates O₃ dissolved in the air. In some circumstances and if not properly managed, O₃ can generate risks to human health. The XSafe appliance is designed to produce O₃ below the legal limits when properly installed, used and maintained.
- ⚠ Improper use of the device or damage to the container can lead to the release of dangerous UV radiation. UV radiation can, even in small doses, cause damage to the eyes and skin. Appliances which are obviously damaged must not be used.
- ⚠ This system requires an annual maintenance program to maintain its effectiveness.
- ⚠ The replacement of the UV lamp **CANNOT** be carried out by the user, contact a specialized technician.
- ⚠ Please contact your local distributor or Dealer for an annual maintenance plan.





KNOWING THE APPLIANCE

Before using the appliance it is good to know it thoroughly. This appliance is an ice maker and must only be used to make ice (not as a container for bottles, cans, etc.)

F01 This booklet explains the operation of two different devices; to identify the purchased model, look for its name on the serial plate, located on the back of the appliance ("model" field).

F02 **MXG series models** must be installed on top of a separate ice container;

F02 **AC | EC series models** have an ice container built into the machine.

To avoid possible cold injuries, remove the ice cubes using the scoop "G" (supplied with the models with built-in ice container) and PPE devices, such as gloves (not supplied).

Air filter "C", if present, must be inspected and cleaned periodically; for the removal operations and cleaning methods see **F11** page **15**.

Never obstruct front and side ventilation slots "D", they are used to ensure the correct operation of the internal cooling unit.

F03 EC appliances have the pump for draining the water built into the machine; this is useful if there is no drain available near the machine.

The maximum distance between the ice maker and the drain can be **30 meters** in length and **1.5 meters** in height.

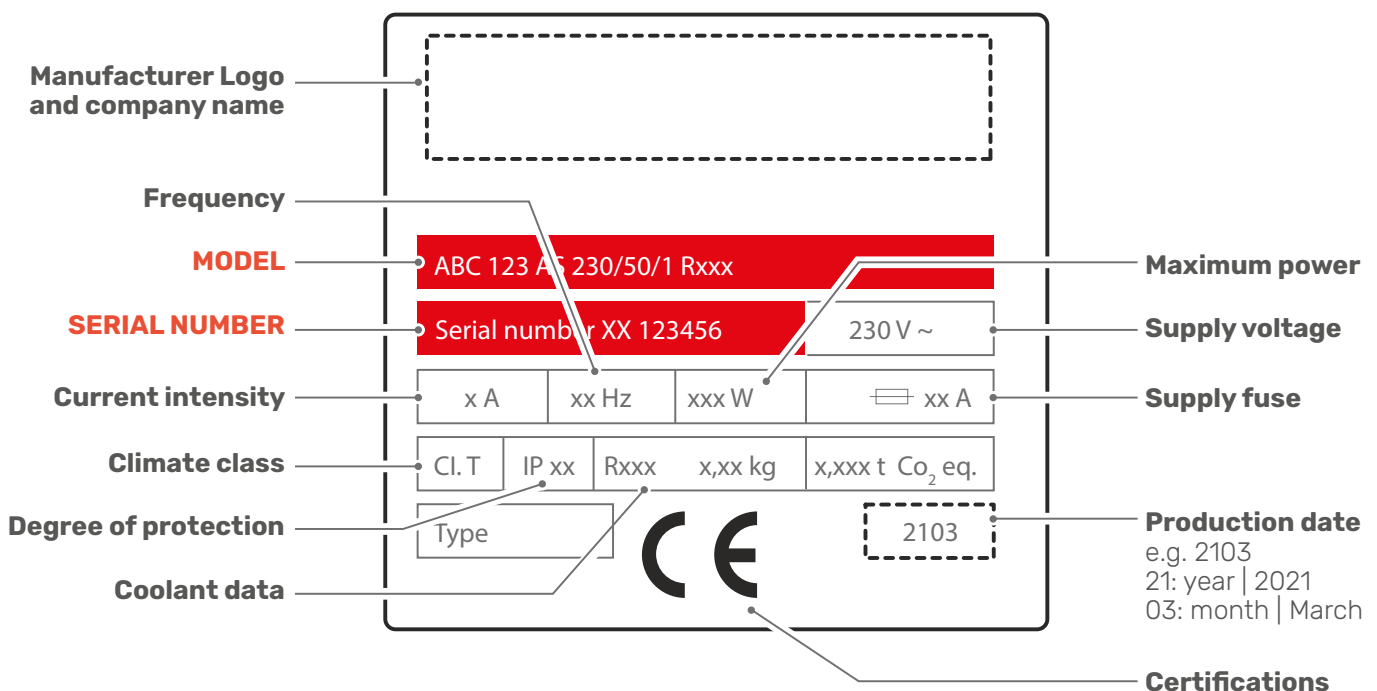

MXG series

Modular ice maker without built-in ice container

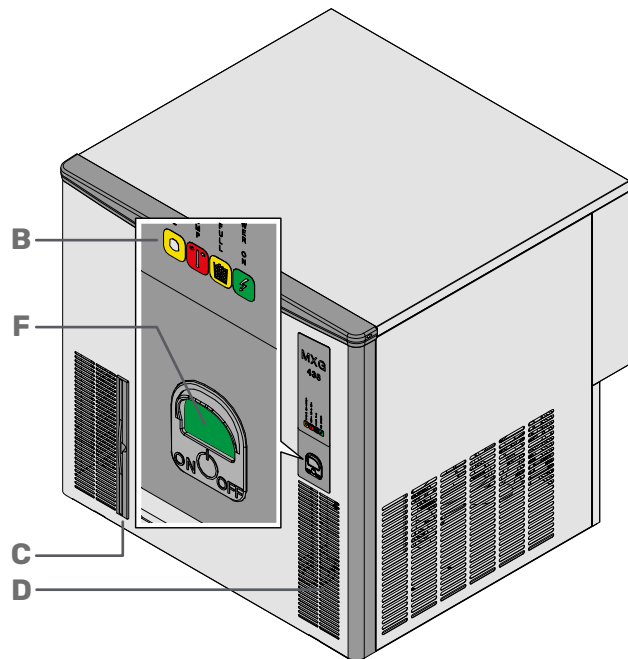

AC | EC series

Modular ice maker with built-in ice container

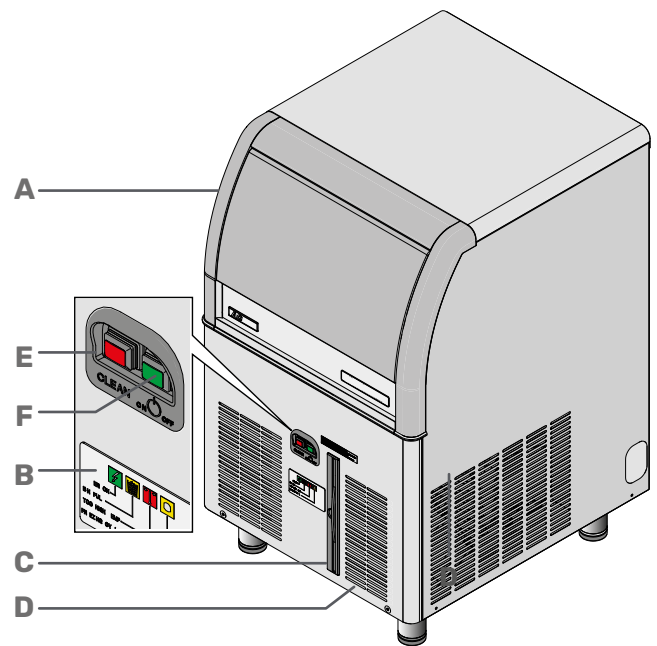

KEY

- A** Ice container door
- B** Warning lights (see page 12 for further explanations)
- C** Air filter (if present)
- D** Front and side air vents
- E** Reset red button (if present) (see page 12 and page 18 for further clarifications)
- F** ON/OFF green button (see page 12 for further clarifications)
- G** Ice scoop (supplied with models with built-in ice container)

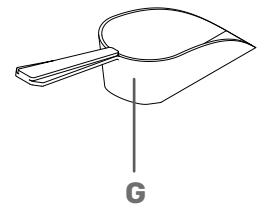

F02

Only for EC models

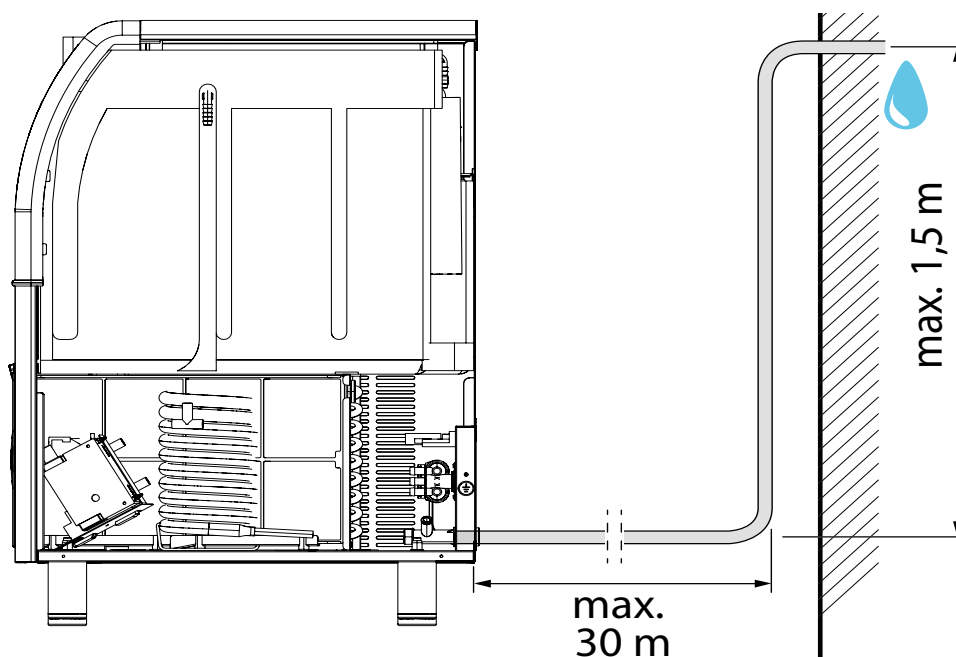

F03

UV AND OZONE LAMP (only for Xsafe models)

F04 This natural sanitation system based on the UV lamp is built in the machine and guarantees absolute purity and hygiene:

- treats the air with ozone technology in the food area of the ice maker;
- keeps the ice maker and the container clean, reduces mould, viruses and other microorganisms;
- it is fully automated and chemical free.

This system requires an annual maintenance program to maintain its effectiveness and replace the UV lamp. The replacement of the UV lamp CANNOT be carried out by the user, contact a specialized technician. Please contact your local distributor or Dealer for an annual maintenance plan.

KNOWING THE BUTTONS AND LIGHTS

F05 **F06** The **“F” ON/OFF green button** turns the appliance on and starts ice cube production. Attention, even if the button is off, the machine is still powered; to turn it off, for example to carry out cleaning or at the end of the working day, set the main system switch to OFF or remove its plug from the socket.

Indicator lights “B” give useful information on the status of the machine.



Powered machine warning light

If on, it indicates that the machine is electrically powered (plug inserted and the main switch of the room system in the ON position).



Container full warning light

If on, it shows that the ice container is full: remove the ice cubes.



Alarm warning light

If on STEADY, it highlights an alarm due to the cooling condenser excessive temperature.

If FLASHING, it highlights an alarm due to the evaporator excessive temperature.

See table on page **18**



Machine in operation/refrigeration cycle warning light

If on, it indicates that the machine is making ice cubes.

F06 The **“E” red button**, if present, highlights an alarm or performs a reset, see chapter **Alarms** on page **18** for further information.

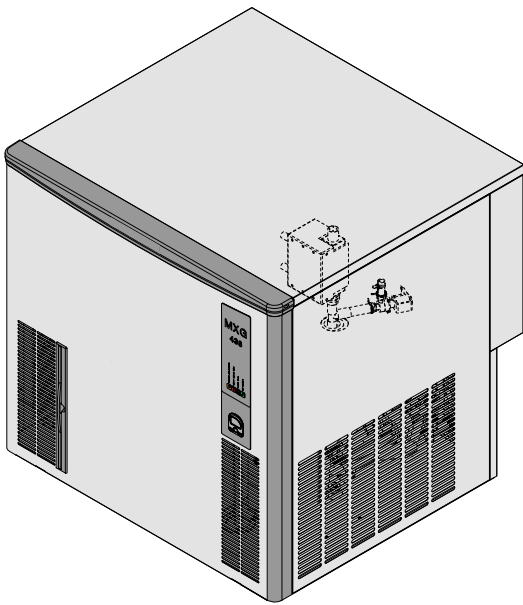

Warning label of the XSafe device positioned inside the ice maker.

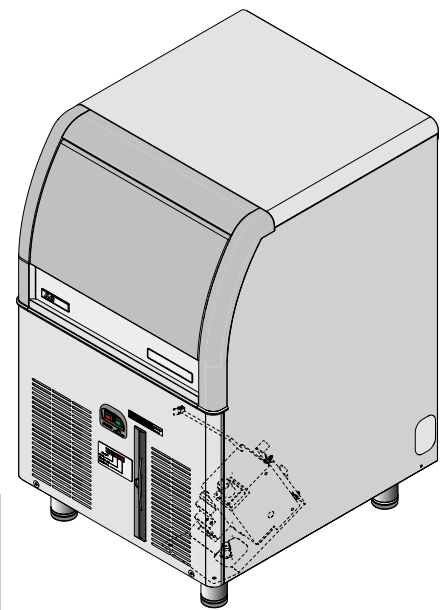

F04

MXG series

Modular ice maker without built-in ice container

AC | EC series

Ice maker with built-in ice container

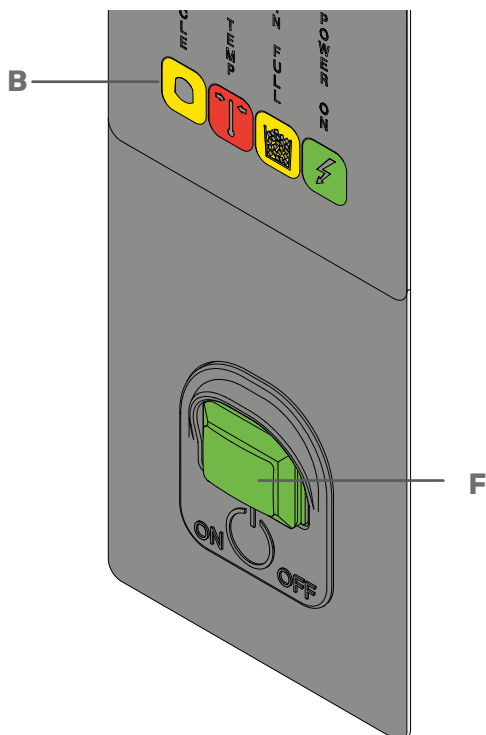

F05

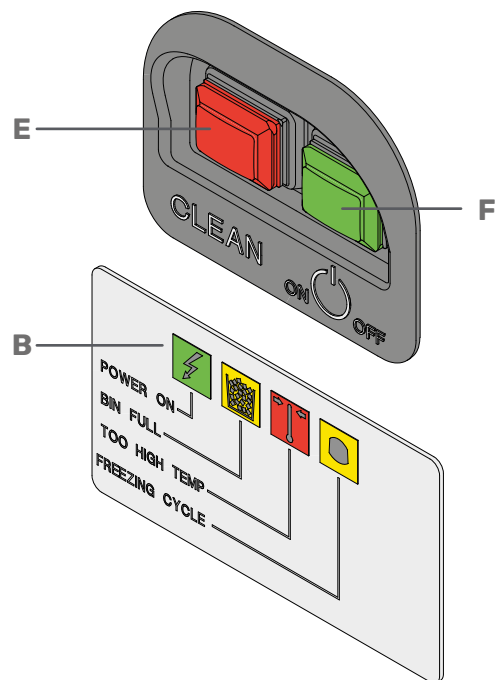

F06

USING THE APPLIANCE

This appliance can be used by children aged 8 and over and by people with reduced physical, sensory or mental abilities or with a lack of experience and knowledge only if they have been adequately instructed and supervised in the safe use of the appliance and have learned the possible dangers derived from its use.

F07 Starting the machine

- 1 Power the machine** inserting its plug into a socket with adequate capacity and turning the switch that powers the socket to ON or, if the machine has been connected to an electrical panel, set the main switch of the panel to ON: the machine is now powered up.
- 2** Open the **water supply tap** so that the machine can load the water.

F07 Ice cube production start

- 3 Press the green ON/OFF button** (if present in your model): the green "machine powered" light comes on. In models without the green ON/OFF button, no operation is required.
- 4** The appliance starts loading water automatically. After about **5 minutes** loading is completed, the yellow "machine running" light comes on and the ice cube production cycle begins.

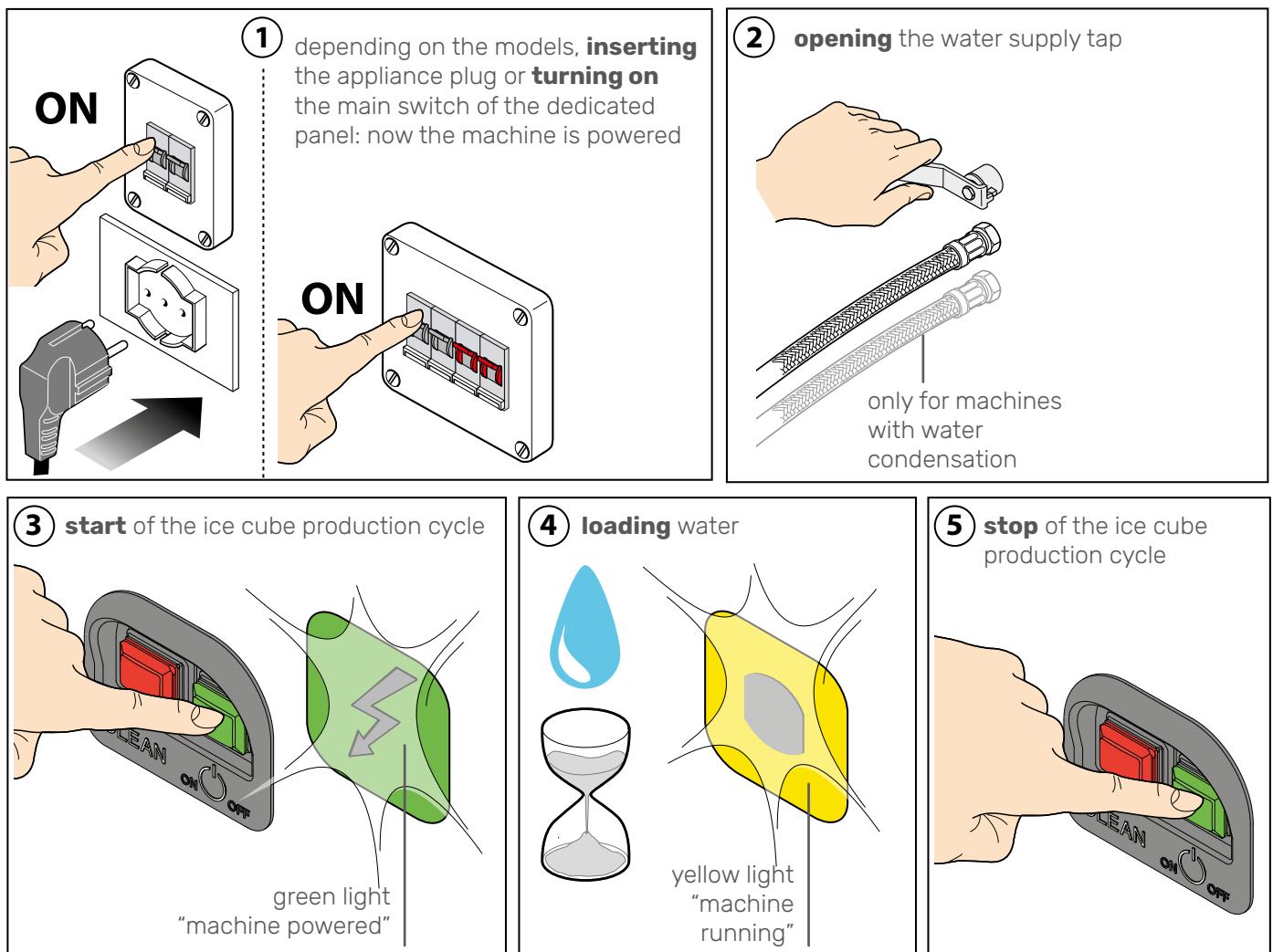

F08 After about 20-30 minutes (depending on the model) the first cubes will be released which can then be removed from the container using the scoop provided. Subsequently, at intervals of about 20-30 minutes other ice cubes will be released continuously, without needing to press any button.

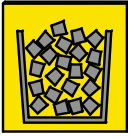

To avoid overfilling the integrated container and possible leakage of ice cubes, inside the container there is a sensor that stops production if the maximum capacity level is exceeded; when the "container full" light comes on, the ice container is full and ice production is temporarily interrupted. When the cubes are removed and the level is lowered, the "container full" light goes off and the machine automatically resumes production without the operator needing to intervene in any way.

After removing the ice, the scoop must be placed inside the collection container on the appropriate support (if any); to avoid contamination of the ice, use only the scoop provided and sanitize it frequently.

F07 Ice cube production stop

5 To stop cyclic ice production, press the green ON/OFF button (if present). In models without the ON/OFF green button, to stop production, unplug the appliance or turn off the switch that powers the socket or the electrical panel to which the appliance is connected.

⚠ Even if the button is off, the machine is still powered up.

Turning the machine off

To turn the machine off, for example to carry out cleaning or at the end of the working day, unplug or turn off the switch that powers the socket or the electrical panel to which the appliance is connected.

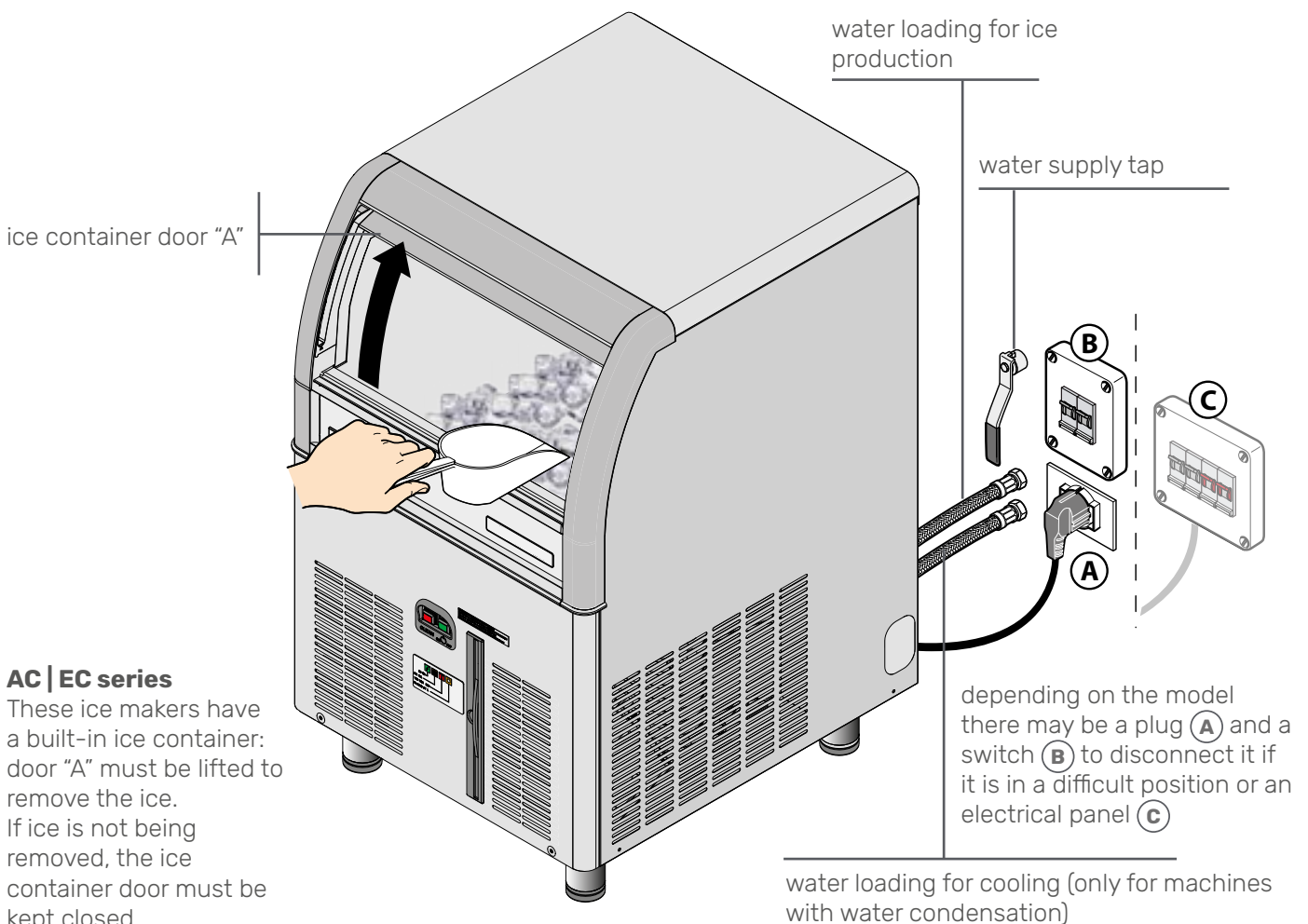

AC | EC series

These ice makers have a built-in ice container: door "A" must be lifted to remove the ice. If ice is not being removed, the ice container door must be kept closed.

CLEANING AND MAINTENANCE OF THE APPLIANCE

Ordinary cleaning

⚠ Before carrying out any ordinary or extraordinary maintenance, it is necessary to disconnect the appliance from the power supply, close the water supply tap and wear appropriate personal protective equipment (e.g. gloves, etc ...).

Ordinary cleaning is intended to keep the appliance in good operating condition and prevent the proliferation of bacteria.

To clean any component or accessory DO NOT use:

- abrasive or powder detergents;
- aggressive or corrosive detergents (e.g. hydrochloric or sulphuric acid, caustic soda, etc.). Caution! Never use these substances also when cleaning the floor under the appliance;
- abrasive or sharp tools (e.g. abrasive sponges, scrapers, steel brushes, etc.);
- steamed or pressurised water jets.

The user must carry out only routine maintenance, for any extraordinary maintenance, contact a Service Centre requesting service from an authorised technician. The cleaning of the appliance is reserved only for suitable and capable personnel and must not be carried out by children.

DAILY

Clean the **ice scoop** with the manufacturer's disinfectant mixed with warm water (1 ml in 1 litre of water, the dilution percentages are also indicated on the rear label of the product). Finish rinsing and drying it thoroughly.

MONTHLY

Clean the ice **collection compartment** with a soft cloth soaked with the manufacturer's disinfectant mixed with warm water (1 ml in 1 litre of water, the dilution percentages are also indicated on the rear label of the product). Finish with a thorough rinsing.

Clean the **external surfaces** with a soft cloth moistened with a specific product for stainless steel, free of acid, aggressive or abrasive agents. For how to use it, refer to the instructions provided by the manufacturer of the chosen detergent.



The manufacturer's disinfectant is the only one tested and guaranteed to thoroughly sanitize all surfaces in contact with the ice, in full compliance with the construction materials. Contact the official local Manufacturer/Distributor for any purchase.

F09

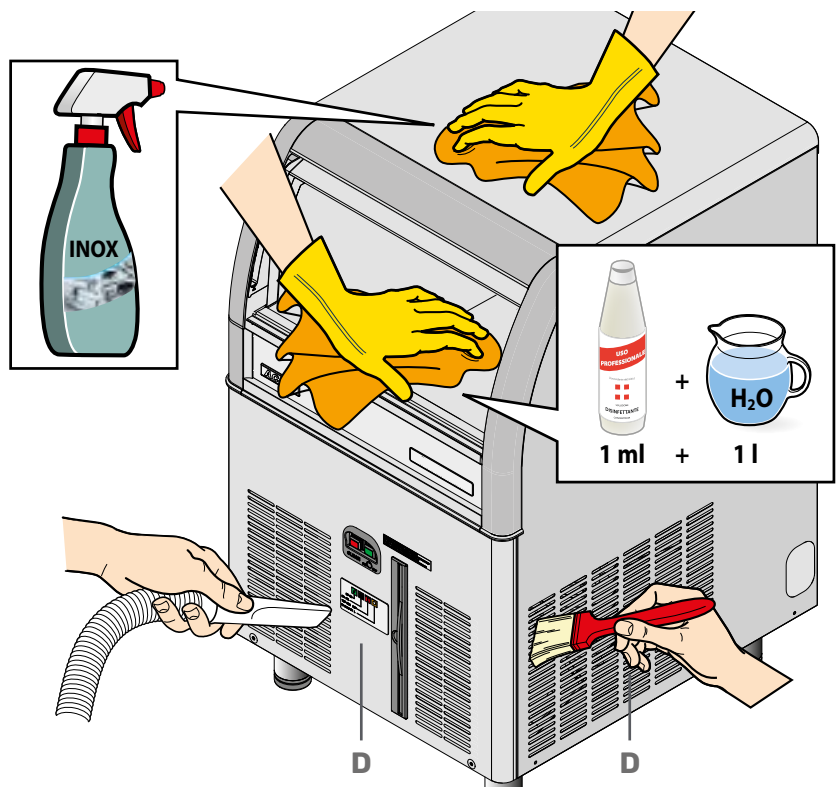

F10

F10 Clean the front or side **air vents "D"** with a soft bristle brush or vacuum cleaner.

F11 Remove **air filter "C"** (if present), wash it with warm water and soap, rinse it thoroughly and reposition it only after it has completely dried.

F12 Remove the **spring "M"** and the **silicone cap "T"** of the water circuit (if present); wash the latter with soap and water, taking care to remove all the accumulated limescale, using a sponge if necessary. When cleaning has been completed, rinse it with running water and put it back in its seat locking it with spring "M".

Clean the **control panel** and the **door** with a soft cloth slightly moistened with a neutral detergent suitable for delicate surfaces. For how to use it, refer to the instructions provided by the manufacturer of the chosen detergent.

EVERY 6 MONTHS / 1 YEAR

Contact the official local Dealer/Distributor for washing, descaling and sanitizing the water circuit.

EVERY YEAR

Contact your official local Dealer/Distributor for the annual maintenance plan and XSafe lamp replacement.

⚠ Proper and timely maintenance is essential to ensure health safety and maintain excellent performance of the appliance over time.

Filter "C" is present only in air-cooled machines

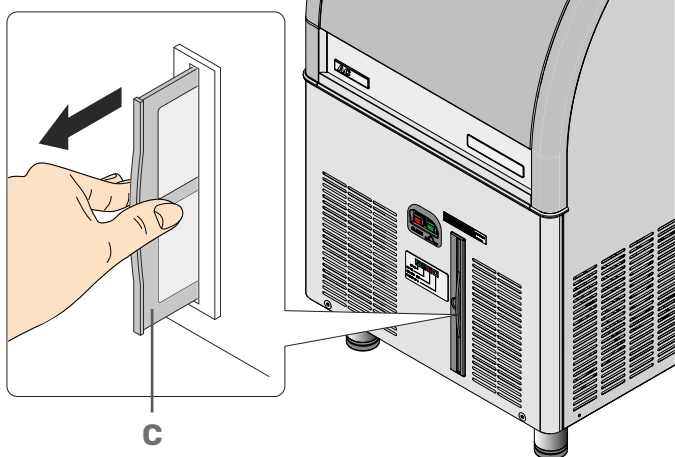

F11

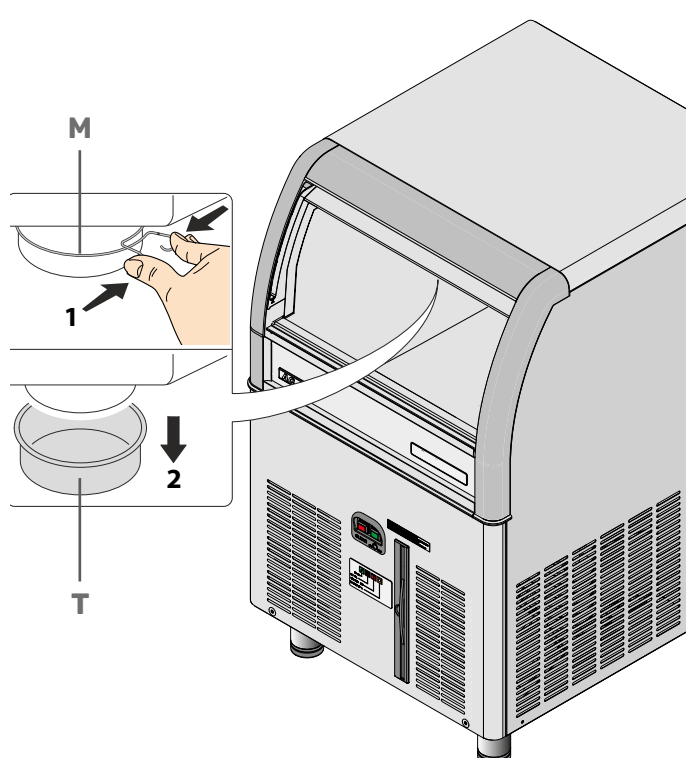

F12

Downtime

During any downtime, switch the power and water off.

Before resuming operations:

- accurately clean the appliance and accessories (if present);
- submit the appliance to the water circuit check and cleaning;
- reconnect the appliance to the power and water supply.

Extraordinary maintenance

Extraordinary maintenance, such as the replacement of a faulty component, must only be performed by qualified personnel authorized by the Manufacturer. The Manufacturer accepts no liability and does not recognize the warranty if the user independently carries out or has unqualified personnel carry out extraordinary maintenance.

End of life disposal



IT08020000000615

Implementing Directives 2011/65/EU and 2012/19/EU on the disposal of waste electrical and electronic equipment. The crossed-out bin symbol indicates that the product at the end of its useful life must be collected separately from other waste. The separate collection of this appliance at the end of its life is organized and managed by the manufacturer. The user who wants to get rid of this appliance must then contact the manufacturer and follow the system that he has adopted to allow the separate collection of the appliance that has reached the end of its life.

Adequate separate collection for the subsequent start-up of the decommissioned appliance for recycling, treatment and environmentally compatible disposal helps to avoid possible negative effects on the environment and health and favours the recycling of the materials of which the appliance is made.

Illegal disposal of the product by the holder involves the application of administrative penalties provided for by the current legislation.

SERVICE

Your appliance is reliable and sturdy but sometimes small problems may arise that, thanks to our service centres, are quickly resolved.

Before contacting them:

- try and refer to the following tables;
- get the model and serial number of the appliance, both of which can be found on the serial number plate on the back of the appliance (see **F01** page **8**)
- find the purchase invoice for the appliance.

If there is a need to replace faulty parts, keep them and entrust them to the installer in charge for replacement so that they can be sent to the Manufacturer for the necessary checks.

Do not attempt to repair the appliance on your own: this could cause serious damages to people, animals and property and voids the Warranty.

Always request service by a service centre authorised by the manufacturer and request ORIGINAL spare parts.

Manufacturer:

Scotsman Ice Srl - Via Lainate 31
20005 Pogliano Milanese - Milano - Italy
Phone: +39 02 93960 208
Fax: +39 02 93960201
sales@scotsman.it



Model: _____

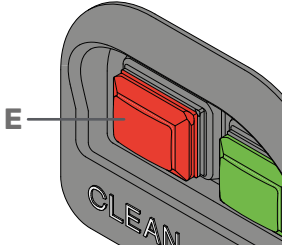

Serial number: _____

Problems and solutions

PROBLEM	SOLUTION
<p>The appliance does not switch on</p>	<ul style="list-style-type: none"> • Check that there is no black-out, that the main switch of the dedicated panel has not blown and that the plug is correctly inserted in the socket. <p>If none of these solutions solves the problem, contact Technical Assistance.</p>
<p>The appliance makes no ice cubes or production is limited.</p>	<ul style="list-style-type: none"> • Check that the appliance is not near another very hot one (e.g. oven). • Check that ambient temperatures do not exceed 43°C. • Check that the water tap is open (see F07 page 12). • Check that air filter "C" (if present) is not clogged, if necessary clean it (see F11 page 15). • Check that front or side air vents "D" are not obstructed by objects or dust (see F10 page 14). Switch the appliance off and back on, <p>If none of these solutions solves the problem, contact Technical Assistance.</p>
<p>The appliance makes imperfect cubes</p>	<ul style="list-style-type: none"> • Check that the inlet water pressure is between 1 Bar and 5 Bar. • Check the water system for obstructions. <p>If none of these solutions solves the problem, contact Technical Assistance.</p>
<p>The appliance is very noisy</p>	<ul style="list-style-type: none"> • Check the appliance touches no other apparatus, object or machine. • Check the appliance is perfectly level. • Check that all visible screws are properly tightened. <p>If none of these solutions solves the problem, contact Technical Assistance.</p>
<p>The red alarm light comes on</p> 	<p>If on:</p> <ul style="list-style-type: none"> • FIXED indicates an alarm due to excessive temperature of the cooling condenser: check that the appliance is not close to another very hot one (e.g. oven) or that ambient temperatures do not exceed 43°C. • FLASHING indicates an alarm due to excessive evaporator temperature: check that the appliance is not close to another very hot one (e.g. oven) or that the ambient temperatures do not exceed 43°C. • Check that the air filter "C" (if present) is not clogged, if necessary clean it (see F11 on page 15). • Check that the inlet water pressure is between 1 Bar and 5 Bar. <p>If none of these solutions solves the problem, contact Technical Assistance.</p>
<p>Red alarm button "E" lights up (if present)</p> 	<p>See chapter Alarms on page 18</p>

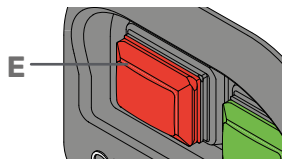
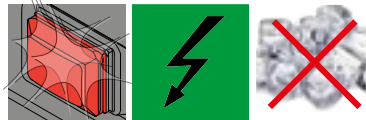
Alarms

RED BUTTON APPEARANCE	WHAT IT MEANS ...	SOLUTION
<p>Red button on steady green light on Ice production</p> 	<p>Cooling condenser critical temperature alarm</p>	<ul style="list-style-type: none"> Air cooled machines: check that air filter "C" is not clogged, if necessary clean it (see F11 page 15). Water-cooled machines: check that the water supply tap is open (see F07 page 12). Check that the inlet water pressure is between 1 Bar and 5 Bar. Check that the appliance is not close to another very hot one (e.g. oven) or that the ambient temperatures do not exceed 43°C. <p>After eliminating the cause of the high temperature, if any, wait for the temperature to drop: the alarm resets automatically.</p> <p>If the problem persists, contact Technical Service.</p>
<p>Red button on steady green light on no ice production</p> 	<p>Cooling condenser high temperature alarm</p>	<ul style="list-style-type: none"> Air cooled machines: check that air filter "C" is not clogged, if necessary clean it (see F11 page 15). Water-cooled machines: check that the water supply tap is open (see F07 page 12). Check that the inlet water pressure is between 1 Bar and 5 Bar. Check that the appliance is not close to another very hot one (e.g. oven) or that the ambient temperatures do not exceed 43°C.  <p>After eliminating the cause of the high temperature, if any, wait for the temperature to drop: try to carry out a reset by holding down red button "E" for 5 seconds or turn the machine on and off by removing and reinserting its plug.</p> <p>If the problem persists, contact Technical Service.</p>
<p>Red button with double flashing green light on Ice production</p> 	<p>Faulty condenser probe alarm</p>	<p>Contact Technical Service</p>

BUTTON APPEARANCE	WHAT IT MEANS ...	SOLUTION
<p data-bbox="100 383 399 495">Red button flashing fast green light on no ice production</p> 	<p data-bbox="504 483 820 551">Drain pump alarm (if any), possible fault</p>	<p data-bbox="861 506 1177 528">Contact Technical Service</p>
<p data-bbox="100 864 424 976">Red button flashing slowly green light on Ice production</p> 	<p data-bbox="504 831 820 931">Reminds you the machine annual maintenance is required</p> <p data-bbox="504 954 836 1178">  Proper and timely maintenance is essential to ensure health safety and maintain excellent performance of the appliance over time. </p>	<ul data-bbox="861 875 1458 1133" style="list-style-type: none"> • Air cooled machines: clean air filter "C" (see F11 page 15). • Clean the silicone cap "T" of the water circuit (see F12 on page 15). • Contact the official local Dealer/Distributor for washing, descaling and sanitizing the water circuit.

EU DECLARATION OF CONFORMITY

2011/65/EU; 2014/30/EU; 2014/35/EU;

Scotsman[®]

We

Scotsman Ice Srl - Via Lainate 31 - 20005 Pogliano Milanese - Milan - Italy

declare under our responsibility that the product:

FABBRICATORE DI GHIACCIO

AC 25 A - AC | EC 36|46|47|56|57|86|87|106|107|126|127|176|177|206|226 A | W

MXG 327|328|427|428|437|438|638|938 A | W | RC

To which this declaration refers, is in compliance with Directives:

- 2011/65/EU "RoHS";

and the following standards or other regulatory documents:

EN 60335-1 (2012) + A11 (2012) + AC (2014) + A13 (2017); EN 60335-2-24 (2010); EN 55014-1 (2006) + A1 (2009) + A2 (2011); EN 55014-2 (1997) + A1 (2001) + A2 (2008); EN 61000-3-2 (2006) + A1 (2009) + A2 (2009); EN 61000-3-3 (2008); EN 61000-4-2 (2009); EN 61000-4-3 (2006) + A1 (2008) + A2 (2010); EN 61000-4-4 (2012)2; EN 61000-4-5 (2006); EN 61000-4-6 (2009); EN 61000-4-11 (2004); EN 62233 (2008)

POGLIANO MILANESE

29/03/2022

SCOTSMAN ICE

Ing. T. Vania

Technical Director





Any unauthorized reproduction, even partial, of the content of these instructions is expressly prohibited.

These instructions and all accompanying documentation have been checked prior to sale.

If errors or inaccuracies are found, please inform the Manufacturer.

The manufacturer reserves the right to make improvements to the appliance or accessories at any time, without notice.

Measurements are purely indicative and not binding. In the event of disputes, the original language of the manual is Italian.

The Manufacturer is not responsible for any translation/interpretation errors.



SCOTSMAN Srl
Scotsman Ice Srl - Via Lainate 31
20005 Pogliano Milanese - Milano - Italy
Phone: +39 02 93960 208
Fax: +39 02 93960201
sales@scotsman.it